

KVT Series: The KVT series vacuum models work on the principle of a positive-displacement pump that consists of vanes mounted in a rotor rotating inside of a cylinder. The carbon graphite vanes slide into and out of the rotor freely sealing on all edges creating chambers totally oil free.

Product Description: The Becker KVT 3.60, 3.80, 3.100, 3.140 and Picchio vacuum pumps are 100% oil-less rotary vane vacuum pumps designed to operate on a continuous basis at any point from atmospheric pressure to a maximum vacuum level of 27"HgV, depending on the model. Prior to handling the vacuum pump, these operating, installation and safety instructions shall be read and understood.

Check boxes next to explanation if you have understood the information.

Call factory for any concerns.



The KVT series are dry rotary vane vacuum pumps intended for suction of air and other dry inert gases. Maximum Allowed Temperature of the inlet air/inert gas - **113 deg F. (45 deg C)**
Ambient temperature: 41-113 deg F Ambient pressure: Atmospheric



Warning. Danger. Caution. Note that ignoring notices may lead to accidents; minor, serious or fatal injuries to personnel; or may cause damage to the pump. If anything remains to be clarified, please contact your Becker Pumps representative.



The vacuum pump is set up for continuous operation, intended for suction or evacuation of the process involving air only and other dry, non-aggressive, non-toxic and non-explosive gases. Conveying higher density media leads to possible excessive thermal/mechanical load on the vacuum pump. Please consult with Becker Pumps when conveying these other vapors/media.



Liquids may not be conveyed. Possibly use version with corrosion protection coating capable of conveying water vapor.



The vacuum pump should be placed in a non-potentially flammable/explosive/non-toxic environment. Therefore:



Flammable Substances may not be conveyed.



Explosive substances may not be conveyed.



Toxic substances may not be conveyed. (Install pump only in non-hazardous environments)



The pump is a dry rotary vane vacuum pump and works without oil. (No oil)
Avoid absorption of oil fumes.



The vacuum pump will become **very hot** during operation. This is normal. Care should be taken to let the unit cool down before maintenance. **(High temps: 175+ degrees F (79 + degrees C)**

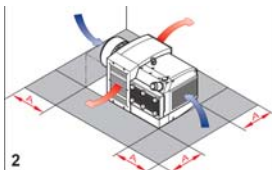

Cooling takes place by radiating heat from the surface of the pump; air flow from the fan wheel across the drive motor and from the air flow of the fan wheel on the shaft of the vacuum pump.

A > 100mm
A > 4"



Greater than 4" (100 mm) around the pump is the distance from any object for radiant heat dissipation. Allow even more area to provide access for maintenance of the pump.



The process gas will also supply cooling to the pump. This process inlet air and the surrounding ambient air should be within temperatures between 41 deg F – 113 deg F.

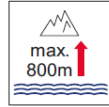

Characteristic data from the spec sheet is valid up to 2625 ft (800 m). Consult with Becker for corrected specifications at altitude. The relief valve on the pump will need to be adjusted.



Protect the pump from humidity in storage/assembly. If placing the pump outside, protect from the outside elements by a protective roof and from rodent/vermin by blocking inlets with wire mesh fencing. Working environment and process application should convey air with a relative humidity between 30-90%.

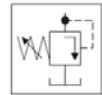

The vacuum pump is equipped with a safety vacuum relief valve. The relief valve is set for the max vacuum level of the pump. The relief valve allows cooling air to enter the pump chamber for further cooling when max vacuum of the pump is attained. The inlet port and the valve itself must be free from obstruction. Consider purchasing a cyclonic filter for worry free operation. (In high altitude applications, the relief valve will be reset for the correct relief at the adapted vacuum level at altitude.)

SET-UP/ ASSEMBLY: Review and identify the position of the (see next page):

- Inlet port** (install piping of the vacuum line from the process to this port without restriction)
- Exhaust port** (leave open to atmosphere without restriction).
- Review and identify** dimensions of the pump, location of inlet filters (to avoid suction of any foreign media), the non-return valve (to avoid reverse rotation after switching off the vacuum pump), and locate the arrows that indicate correct rotation of motor/fan after electrical hook-up.
- Do **not reverse rotation** of the pump, this will spin the vanes backwards incorrectly and possibly break or chip vanes).

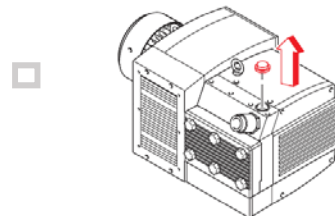

Remove all packing materials: cardboard/plastic covers/adhesive tape/foam from all ports and from the outside of the pump.

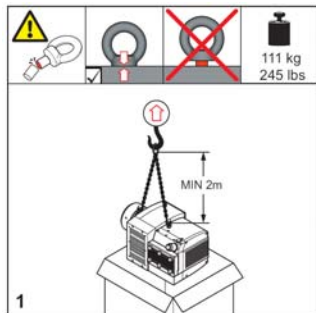

1



Make sure the eyebolts are fully screwed in. The position of the eyebolts fit to the center of gravity of a pump including the drive motor. If a pump without motor is to be lifted, attach another belt/rope at a suitable point.



The pump is intended for industrial use. It shall be handled only by qualified personnel. Only qualified personnel shall transport, store, install, commission, maintain, troubleshoot, and overhaul the pump. The installation of the pump should be observed both by the manufacturer of the machinery into which the pump will be incorporated and by the operator. Marked operations may only be executed by qualified electricians.



Follow all safety notes/warnings.

Always wear eye protection.



During operation, the surface of the pump may reach high temperatures of more than 160 deg F.

Wear protective gloves, stay clear of the pump. Risk of Burns!



The pump emits noise of high intensity in a narrow band. Risk of damage to hearing. Persons in the vicinity of a pump over extended periods shall wear ear protection.

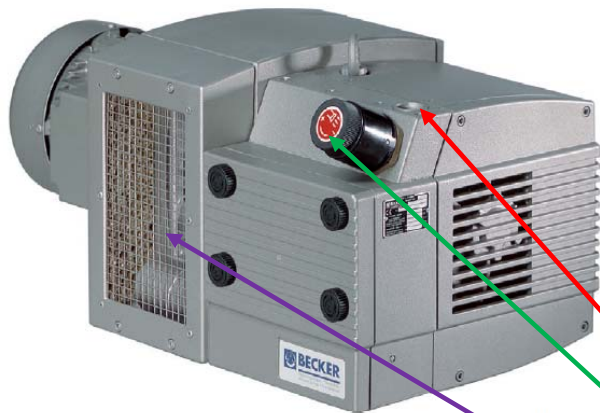
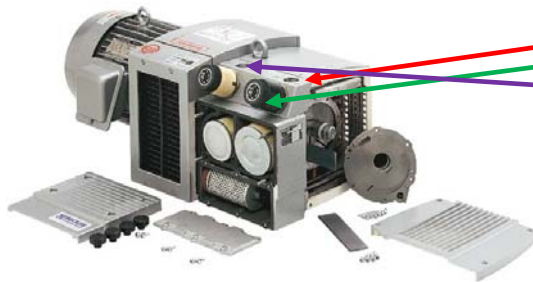
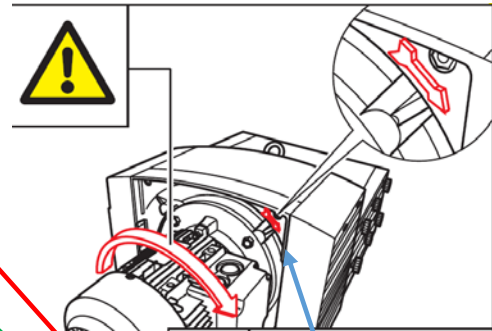

fig: KVT 3.80



- 1.) Vacuum connection
- 2.) Vacuum relief valve with silencer
- 3.) Exhaust air vent and/or exhaust port. (Check port dimensions specified for type of KVT pump model).
- 4.) Arrows to indicate correct rotation of motor/fan.



When servicing the pump, the pump must be turned off. The motor must be disconnected from the main electrical source by a qualified electrician so that it cannot be started up again accidentally. Lockout the motor.

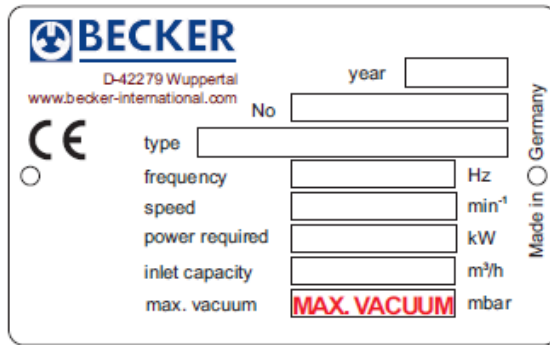

On every pump there will be the **pump nameplate**. It will state: the year the pump was manufactured, the serial number of the pump, the type of pump, frequency, rpm, kW (motor HP), volumetric flow inlet capacity, and the max vacuum. The data sheet will also provide this information.

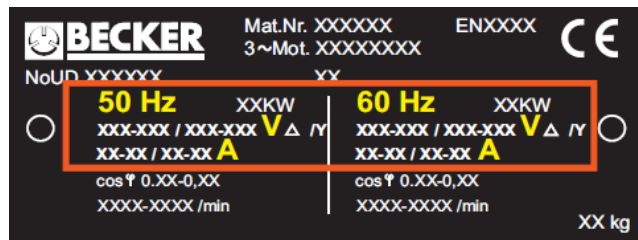

On every motor there will be the **motor nameplate**. It will state the motor electrical information with kW, Hz, voltage, amps, speed, with the wiring diagram on the motor nameplate or inside the motor box, IP rating, UL/CSA recognition, and operating mode (S1).

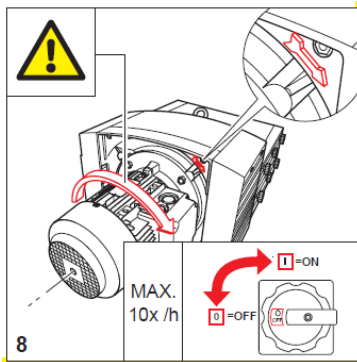

Locate the arrows that indicate correct rotation of motor/fan after electrical hook-up. Do **not reverse rotation** of the pump, this will spin the vanes backwards incorrectly and possibly break or chip vanes. **Bump** the drive motor and watch the fan wheel to determine the direction.

The pump should **not** be switched on/off more frequently than 3 times/hour or 6 times/hour if using a soft start or frequency drive.. This may lead to excess temperature limit of the motor winding and the bearings.

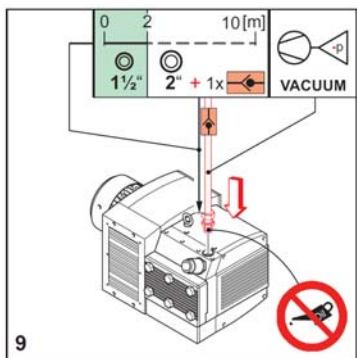

Flexible pipe should be used for pipe connections at an angle. This will prevent pipe line cracks/breakage/damage.

Proper sizing of pipe diameter should not restrict inlet. Piping diameter should be at least the same size as the inlet port size for up to 30 meters (98 ft of equivalent length). Larger pipe diameters should be used for longer equivalent lengths.

An external check valve 1x should be used to prevent reverse operation when there is vacuum in the line, due to when the machine has stopped and also when two or more pumps are inline.

Do not use oil on threads of the piping.

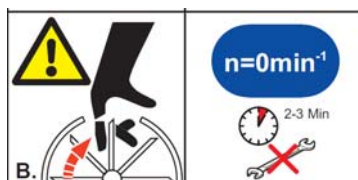

Caution: rotating unit. Do not work on the pump/motor until it is idle with no rotation. This may take up to 3 minutes. Follow proper lockout/tag-out procedures.

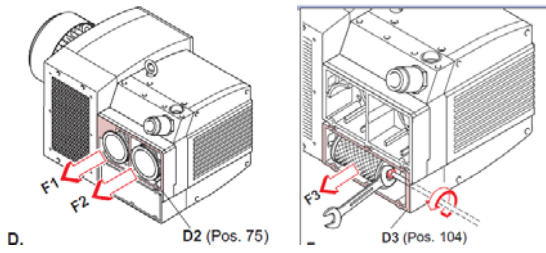

There are internal filter/elements. Every model has filters behind the four or six knobs on the inlet side of the pump (F1, F2). There may be other filter/elements below the main inlet filters (F3).

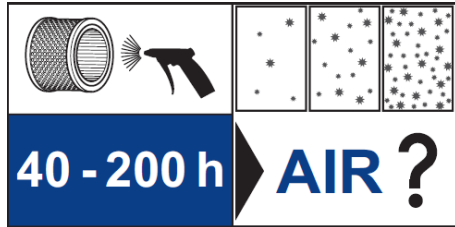

Filter/elements should be checked between 40-200 hours. The elements should be blown with compressed air from the inside out. Blast air should be felt coming through the filter/element. The element needs to be replaced if dirty or clogged. **Use only Becker Genuine filters to maintain warranty protection.**

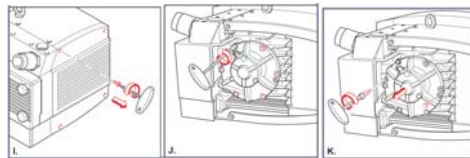

After 3000 hours of run time on the pump, the vanes will need to be checked for wear. To open vane location area, remove plastic end cover, unscrew bolts and feed bolts back into threaded ports to remove end shield. Depending on pump type, the A max/A min = (Vane Height Max)/(Vane Height Min) is 39/21 mm = KVT3.60; 39/26 mm = KVT 3.80 and KVT 3.100; 39/30 mm = Picchio; and 48/31 mm = KVT 3.140.

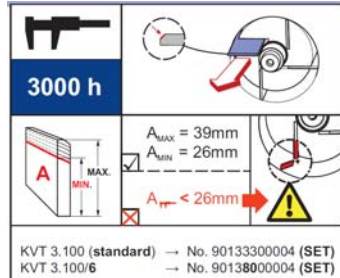

The vanes will need to be replaced when the A min (Vane Height Minimum) is reached. Before replacement blow out the housing and the rotor slot. When changing vanes, the sloping side (beveled) of the vane is away from the direction of rotation. Before startup, check that the vanes run freely by moving the rotor around.

Caution: If vanes are allowed to wear past the minimum height, the vanes may break. **Replace** vanes before reaching minimum height. **Use only Becker Genuine vanes to maintain warranty protection.**

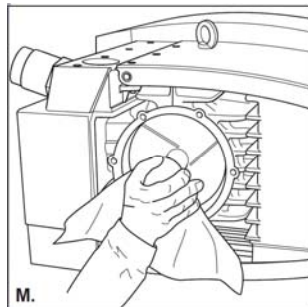

Wipe away any excess grease from the rotor shaft. (M.)

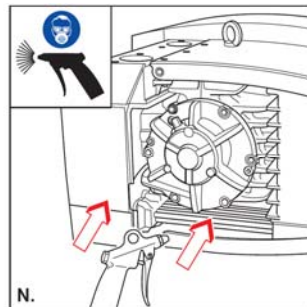

Fully insert pins before tightening end shield bolts. If not aligned properly, this may offset tolerance.

Wear dust masks and eye protection/goggles that protect against dust, debris, powders and airborne particles. (N.)

Blow out cooling fins and underneath plastic shrouds removing any debris. (N.)

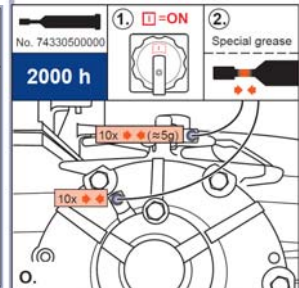
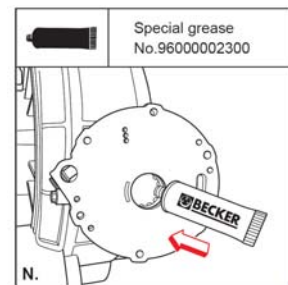

Grease bearing at 2,000 hours of run time on the pump. Locate grease gun. Depending on pump type, the grease will need to be hard packed (N) or pushed into fittings found behind the end chamber cover. (O.)

Push about 10x into each fitting. This is about 5 grams. **Use only special Becker Amblygon grease to maintain warranty protection.** (P.)

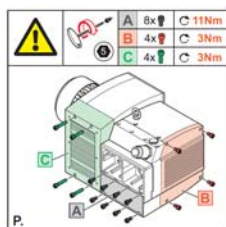

ASK ABOUT OUR MOBILE SERVICE



**Use Only Becker Genuine Replacement Parts To Maintain
Warranty Protection!**

Available Spare Parts/Accessories



Maintenance Kit— Visit Our Store for Part #'s

Use the Becker Genuine Maintenance Kit to maintain your warranty and to increase the longevity and performance of your Becker Rotary Vane Pumps. Each of these components is engineered specifically for this pump. The kit includes Becker Genuine replacement vanes, filter, and grease gun. Keep an extra kit on the shelf to ensure you have all of the components on hand for regularly scheduled maintenance.



BPC Clear Filters

Use an inline see through canister filter with paper filter element that removes 99% of particles down to 2 micron and connects easily on to the Becker Check Valve Assembly. Eliminates the need for removing the filter cover on the pump and allows for visual inspection of the filter element preventing any interruption in the vacuum process.



Check Valve Kit/Gauge

The Check Valve Kit comes complete with all parts necessary to connect to the pump. Liquid filled 0-30" Hg vacuum gauge with 2-1/2" face, 1/4" center back mount easily fits onto the Check Valve Kit piping.

Visit Our Store To See All Available Parts & Accessories!

www.beckerpumps.com/shop